



Technical Specifications







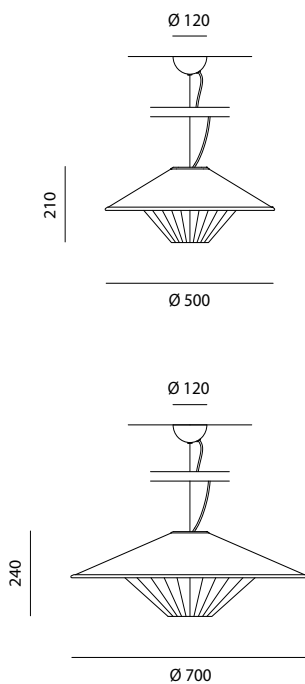



OTTO PENDANT

The *Otto* lamp series channels late 60s and early 70s sci-fi themes, reminiscent of UFOs and amusement park carousels. It combines a bouclé fabric upper hat by Rubelli with a pongè band diaphanous cone for light diffusion, hand-sewn in four melange colors. Offered in two sizes, Otto allows versatile placement or grouping options.



Environment	Indoor
Light source	1 x E27 Bulb Holder E26 Bulb Holder
Voltage	220-240V 110-120V
Power	Max LED 13W
Cable lenght	300 cm
Dimmable	Compatible with dimmable systems
Wiring	CE UL
Weight	Ø50: 1,2 kg Ø70: 1,6 kg

Materials	
Upper Lampshade	Rubelli / Dedar fabric
Lower Lampshade	Pleated pongé
Ceiling Rose	White painted iron

Colors		Azure		Cobalt
		Brown		Yellow
		Ecrù		Salt & Pepper
		Green		Tender Rose
		Pink		